

Jota

Rotierende Dentalinstrumente

Rotary Dental Instruments

Instruments Dentaires Rotatifs

Instrumental Dental Rotatorio





Dear Customers and Partners

Over 100 years of experience and the focus on rotary instruments only are a solid based for our offer of high quality products. We align ourselves at your requirements, add innovation and strive after a maximum of customer satisfaction. Our pride and joy is your loyalty, with many of you since decades. Partnership has its responsibility, and we are committed to continue with all our efforts to provide an outstanding market offer of rotary instruments and services. The current catalogue offers new products, extended and completed product lines and a range of useful information around the optimal applications of rotary instruments. You are a valued customer!

Josef Rauch, CEO



فرزهای الماسی Diamond instruments	2-12
فرزهای کارباید Carbide instruments	13-17
فرزهای استیل Steel instruments	18
مولت های پرداخت سنگی Abrasives	19-20
مولت های پرداخت Polishers & Brushes	21-23
محصولات اندو Endodontics	24
فرزهای جراحی فک و صورت Oral and Maxillofacial Surgery	25-26
محصولات جانبی Accessories	26
محصولات لابراتواری Dental Laboratory	27-30



مشخصات باند فرزهای الماسی

		باند مشکی	الماسهای بسیار درشت	SG
		مخصوص تراش	151-213 µm	544
		باند سبز	الماسهای درشت	G
		مخصوص تراش	107-181 µm	534
		باند آبی	الماسهای متوسط	
		مخصوص تراش	64-126 µm	524
		باند قرمز	الماسهای ریز	F
		مخصوص پالایش	27-76 µm	514
		باند زرد	الماسهای بسیار ریز	EF
		مخصوص تراش	10-36 µm	504
		باند سفید	الماسهای بسیار بسیار ریز	UF
		مخصوص تراش	4-14 µm	494





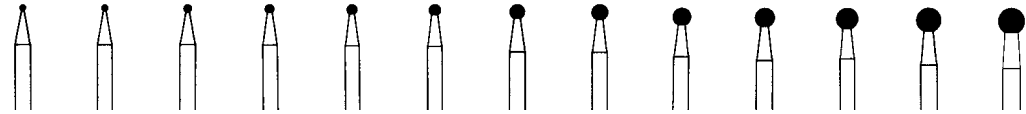

A	B	C	D	E	F	G	H
Match Code	Figure-Number	Shank	Diameter	HIBC Code (ISO, LOT, Package)	ISO-Number	Recommended speed	Lot-Number

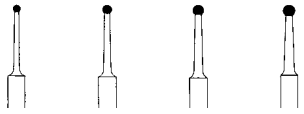
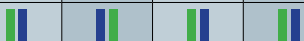



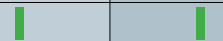

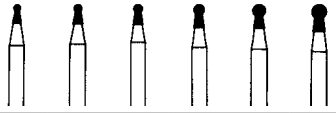
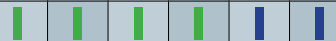

801	kugelförmig (rund) spherical (round)
	
ISO	Ø
806 314 001	009 010 012 014 016 018 021 023 025 027 029 033 035
باند‌های موجود	



801L	rund, extra langer Hals spherical, extra long neck
	
ISO	Ø
806 314 697	010 012 014 016
باند‌های موجود	

801L	kugelförmig (rund) spherical (round), Long shank
	
ISO	Ø
806 316 001	018 023
باند‌های موجود	

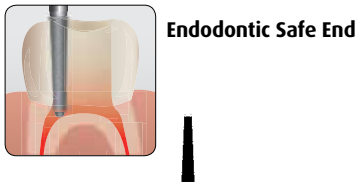
802	rund, mit Ansatz spherical, with collar
	
ISO	Ø
806 314 002	010 012 014 016 018 021
باند‌های موجود	

802L	rund, konischer Ansatz, lang spherical, conical collar, long
	
ISO	Ø
806 314 494	012 016 019
باند‌های موجود	
	L mm
	10.0 10.0 10.0

802K	konisch, Kugel, Seite schneidend conical with ball, side cutting
	
ISO	Ø
806 314 551	014
باند‌های موجود	
	L mm
	8.3

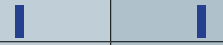
389	rund, konischer Ansatz, lang spherical, conical collar, long
	
ISO	Ø
806 316 494 020	012 014
باند‌های موجود	
	L mm
	8,0 8,0

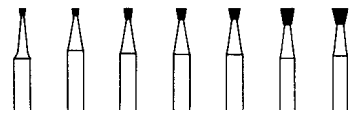

805 umgekehrter Kegel
inverted conical

ISO	Ø						
806 314 012	009	010	012	014	016	018	021
باند‌های موجود							
L mm	0.9	1.0	1,5	1,5	1,5	2,3	2,3

806 umgekehrter Kegel, mit Ansatz
inverted conical, with collar

ISO	Ø			
806 314 019	010	012	014	016
باند‌های موجود				
L mm	2,5	3,0	3,0	3,0

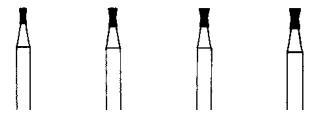
870 Diabolo
diabolo

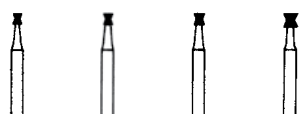

ISO	Ø			
806 314 032	012	014	016	018
باند‌های موجود				
L mm	1,5	1,5	1,7	2,0

807 umgekerkt konisch
inverted conical

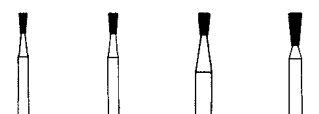
ISO	Ø			
806 314 225	012	014	016	018
باند‌های موجود				
L mm	3,5	3,5	4,0	5,0

808L Stirn konvex, Kante rund, lang
convex end, rounded edges, long

ISO	Ø				
806 314 234	010	012	014	016	018
باند‌های موجود					
L mm	4,0	4,0	5,0	5,0	5,0

808RL Birne
pear





ISO	Ø			
806 314 238	012	014	016	018
باند‌های موجود				
L mm	4,0	5,0	5,0	5,0



151 - 213 µm
ISO: 544
super coarse





107 - 181 µm
ISO: 534
coarse





64 - 126 µm
ISO: 524
medium

811 Doppelkegel, symmetrisch, kurz
Barrel short





ISO	Ø
806 314 038	033
باند‌های موجود	
L mm	4,0

811L Doppelkegel, symmetrisch, lang
Barrel long

ISO	Ø
806 314 039	037
باند‌های موجود	
L mm	7,0



27 - 76 µm
ISO: 514
fine



10 - 36 µm
ISO: 504
extra fine



4 - 14 µm
ISO: 494
ultra fine

815 Rad wheel

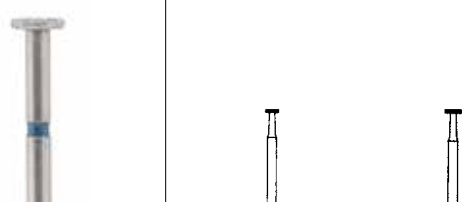

ISO	Ø	
806 314 042	018	023
باند‌های موجود		
L mm	0,5	0,6

818 Rad wheel

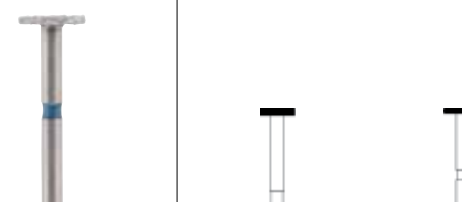

ISO	Ø	
806 314 041	035	045
باند‌های موجود		
L mm	0,6	0,6

820 Interdentalbohrer bur interdental

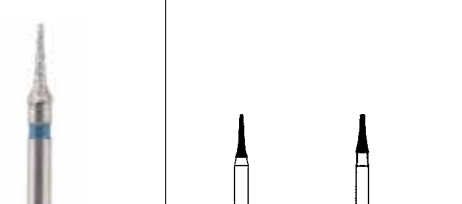

ISO	Ø		
806 314 465	014	016	031
باند‌های موجود			
L mm	5,0	5,0	4,0

822 Rad wheel

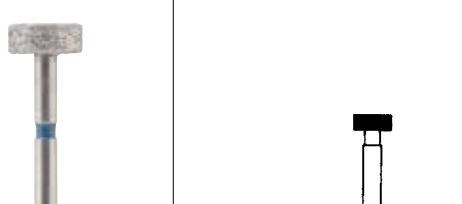

ISO	Ø
806 314 042	050
باند‌های موجود	
L mm	2,0

825 Linse lens

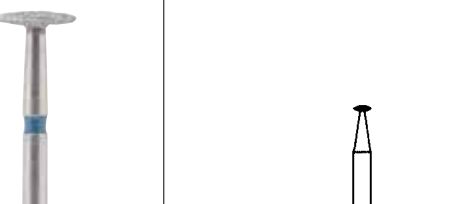

ISO	Ø
806 314 304	023
باند‌های موجود	
L mm	0,6

827 Zwiebel onion

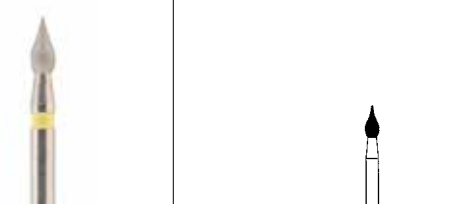

ISO	Ø
806 314 464	018
باند‌های موجود	
L mm	4,0

829 konisch konkave Stirn conical concave tip



ISO	Ø
806 314 463	027
باند‌های موجود	
L mm	1,6

830 Knospe, schlank bud, slender



ISO	Ø			
806 314 257	016	018	021	023
باند‌های موجود				
L mm	4,5	4,5	5,0	5,0



831 Knospe bud

ISO	Ø	
806 314 254	016	018
باند‌های موجود		
L mm	3,5	3,5

833 Ei egg





ISO	Ø				
806 314 277	014	016	018	021	023
باند‌های موجود					
L mm	2,8	3,4	3,4	4,2	4,2

833L Ei, lang egg, long



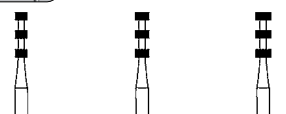

ISO	Ø
806 314 278	018
باند‌های موجود	
L mm	5,0

834 Instrument zur Tiefenmarkierung instrument for depth marking

ISO	Ø		
806 314 552	016	018	021
باند‌های موجود			
L mm	6,0	6,0	6,0

835 zylindrisch, Seite und Stirn schneidend cylindrical, side and end cutting

ISO	Ø							
806 314 108	007	008	009	010	012	014	016	018
باند‌های موجود								
L mm	3,0	3,0	3,0	3,5	3,5	3,5	3,5	3,5

151 - 213 µm
ISO: 544
super coarse

107 - 181 µm
ISO: 534
coarse

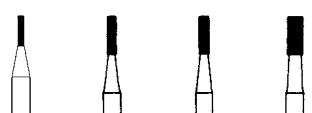

64 - 126 µm
ISO: 524
medium

836 Seite und Stirn schneidend side and end cutting

ISO	Ø			
806 314 109	008	010	012	014
باند‌های موجود				
L mm	4,0	4,0	4,0	4,0

837 Seite und Stirn schneidend side and end cutting

ISO	Ø				
806 314 110	010	012	014	016	018
باند‌های موجود					
L mm	6,0	6,0	6,0	6,0	6,0

27 - 76 µm
ISO: 514
fine

10 - 36 µm
ISO: 504
extra fine

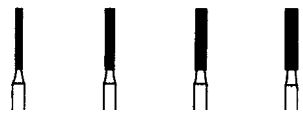

4 - 14 µm
ISO: 494
ultra fine

837L Seite und Stirn schneidend, lang
side and end cutting, long

ISO	Ø			
806 314 111	010	012	014	016
باند‌های موجود				
L mm	8,0	8,0	8,0	8,0

837XL Seite und Stirn schneidend, lang
side and end cutting, extra long

ISO	Ø	
806 314 112	012	014
باند‌های موجود		
L mm	10,0	10,0

838 Stirn rund
end hemispherical

ISO	Ø				
806 314 138	008	009	010	012	014
باند‌های موجود					
L mm	4,0	4,0	4,0	4,0	4,0

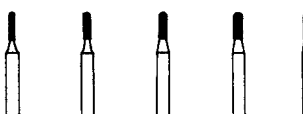
838L Stirn rund, lang
end hemispherical, long

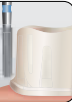

ISO	Ø			
806 314 140	010	012	014	016
باند‌های موجود				
L mm	6,0	6,0	6,0	6,0

881 zylindrisch, Stirn rund
cylindrical, end hemispherical

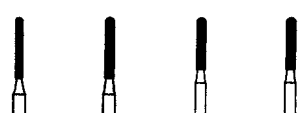

ISO	Ø			
806 314 141	010	012	014	016
باند‌های موجود				
L mm	8,0	8,0	8,0	8,0

882 zylindrisch, Stirn rund
cylindrical, end hemispherical

ISO	Ø	
806 314 142	012	014
باند‌های موجود		
L mm	10,0	10,0

839 nur Stirn schneidend
end cutting only

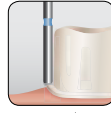
ISO	Ø		
806 314 150	010	012	014
باند‌های موجود			
L mm	0,2	0,2	0,2

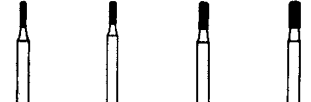

840 zylindrisch, Kante rund
cylindrical, rounded edge

ISO	Ø			
806 314 156	008	010	012	014
باند‌های موجود				
L mm	3,0	4,0	4,0	4,0



841 zylindrisch, Kante rund
cylindrical, rounded edge

ISO	Ø				
806 314 157	008	010	012	014	016
باندهای موجود					
L mm	6,0	6,0	6,0	6,0	6,0

842 zylindrisch, Kante rund
cylindrical, rounded edge

ISO	Ø			
806 314 158	012	014	016	018
باندهای موجود				
L mm	8,0	8,0	8,0	8,0

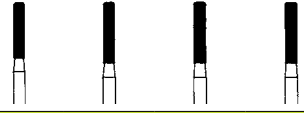
508 Axial Pin Seite schneidend mit Zapfen
side cutting with guide





ISO	Ø	
806 314 508	016	020
باندهای موجود		
L mm	7,5	7,5

845 konisch, kegeltumpfförmig
conical, truncated conical

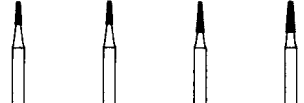
ISO	Ø			
806 314 168	009	010	012	014
باندهای موجود				
L mm	3,0	4,0	4,0	4,0

846 konisch, kegeltumpfförmig
conical, truncated conical

ISO	Ø			
806 314 171	012	014	016	018
باندهای موجود				
L mm	6,0	6,0	6,0	6,0

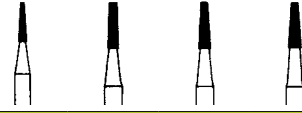
846R konisch, Kante rund
conical, rounded edge

ISO	Ø	
806 314 545	016	018
باندهای موجود		
L mm	6,0	6,0

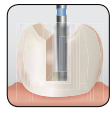
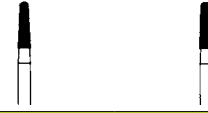

151 - 213 µm
ISO: 544
super coarse



107 - 181 µm
ISO: 534
coarse



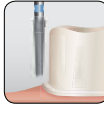
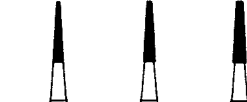

64 - 126 µm
ISO: 524
medium

847 konisch, kegeltumpfförmig
conical, truncated conical

ISO	Ø			
806 314 172	012	014	016	018
باندهای موجود				
L mm	8,0	8,0	8,0	8,0

847R konisch, Kante rund
conical, rounded edge

ISO	Ø		
806 314 546	016	018	023
باندهای موجود			
L mm	8,0	8,0	8,0



27 - 76 µm
ISO: 514
fine



10 - 36 µm
ISO: 504
extra fine



4 - 14 µm
ISO: 494
ultra fine

848 konisch, kegelstumpfförmig
conical, truncated conical

ISO	Ø				
806 314 173	014	016	018	021	023
باند‌های موجود					
L mm	10,0	10,0	10,0	10,0	10,0

848R konisch, Kante rund
conical, rounded edge

ISO	Ø
806 314 553	016
باند‌های موجود	
L mm	10,0

849 konisch, Stirn rund
conical, end domed

ISO	Ø					
806 314 197	010	012	014	016	018	025
باند‌های موجود						
L mm	6,0	6,0	6,0	6,0	6,0	7,0

850 konisch, Stirn rund
conical, end domed

ISO	Ø					
806 314 198	012	014	016	018	021	025
باند‌های موجود						
L mm	8,0	8,0	8,0	8,0	8,0	8,0

Endodontic Safe End

851L nur Seite schneidend, lang
side cutting only, long

ISO	Ø		
806 314 219	012	016	018
باند‌های موجود			
L mm	8,0	8,0	8,0

852 konisch, Stirn rund
conical, end domed

ISO	Ø					
806 314 199	010	012	014	016	018	023
باند‌های موجود						
L mm	10,0	10,0	10,0	10,0	10,0	10,0

858 konisch spitz, schlank
conical pointed, slender

ISO	Ø			
806 314 165	010	012	014	016
باند‌های موجود				
L mm	8,0	8,0	8,0	8,0

859 konisch spitz, schlank
conical pointed, slender

ISO	Ø					
806 314 166	010	012	014	016	018	021
باند‌های موجود						
L mm	10,0	10,0	10,0	10,0	10,0	10,0



859L konisch spitz, schlank, lang
conical pointed, slender, long

ISO	Ø			
806 314 167	010	012	014	016
باند‌های موجود				
L mm	12,0	12,0	12,0	12,0

861 zylindrisch, Stirn flammenförmig
cylindrical, end pointed

ISO	Ø		
806 314 247	010	012	014
باند‌های موجود			
L mm	4,0	5,0	5,0

862 zylindrisch, Stirn flammenförmig
cylindrical, end pointed

ISO	Ø				
806 314 249	010	012	014	016	021
باند‌های موجود					
L mm	8,0	8,0	8,0	8,0	8,0

863 zylindrisch, Stirn flammenförmig
cylindrical, end pointed

ISO	Ø			
806 314 250	012	014	016	018
باند‌های موجود				
L mm	10,0	10,0	10,0	10,0

866 Torpedo, zylindrisch
torpedo, cylindrical

ISO	Ø	
806 314 287	009	010
باند‌های موجود		
L mm	5,0	5,0

867 Torpedo, zylindrisch
torpedo, cylindrical

ISO	Ø		
806 314 288	009	010	012
باند‌های موجود			
L mm	6,0	6,0	6,0

868 Torpedo, zylindrisch
torpedo, cylindrical

ISO	Ø			
806 314 289	010	012	014	016
باند‌های موجود				
L mm	8,0	8,0	8,0	8,0

869 Torpedo, zylindrisch
torpedo, cylindrical

ISO	Ø			
806 314 290	010	012	014	016
باند‌های موجود				
L mm	10,0	10,0	10,0	10,0

- 151 - 213 µm
ISO: 544
super coarse
- 107 - 181 µm
ISO: 534
coarse
- 64 - 126 µm
ISO: 524
medium
- 27 - 76 µm
ISO: 514
fine
- 10 - 36 µm
ISO: 504
extra fine
- 4 - 14 µm
ISO: 494
ultra fine



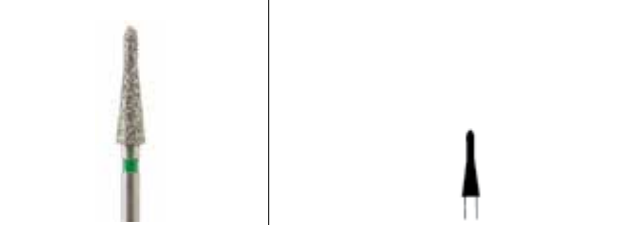

875 Y-Form, Lang
Y-Shape, Long

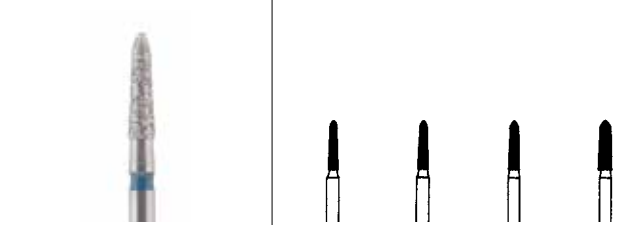

ISO	Ø
806 314 588	025
باند‌های موجود	
L mm	10,0







877 Torpedo, konisch
torpedo, conical

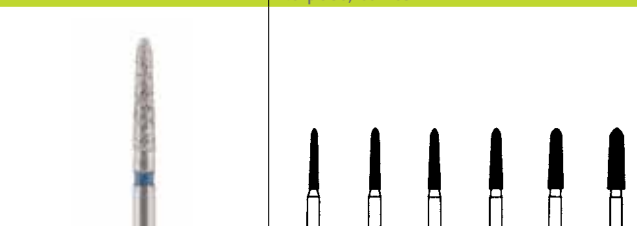

ISO	Ø			
806 314 297	012	014	016	018
باند‌های موجود				
L mm	6,5	6,5	6,5	6,5







878 Torpedo, konisch
torpedo, conical

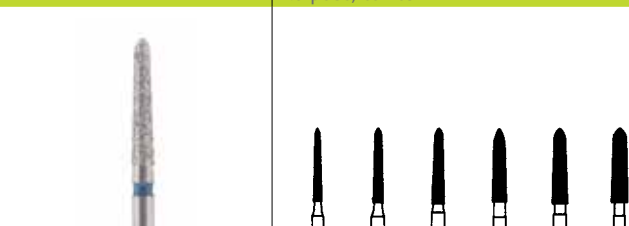

ISO	Ø					
806 314 298	012	014	016	018	021	023
باند‌های موجود						
L mm	8,0	8,0	8,0	8,0	8,0	8,0



879 Torpedo, konisch
torpedo, conical



ISO	Ø					
806 314 299	012	014	016	018	021	023
باند‌های موجود						
L mm	10,0	10,0	10,0	10,0	10,0	10,0

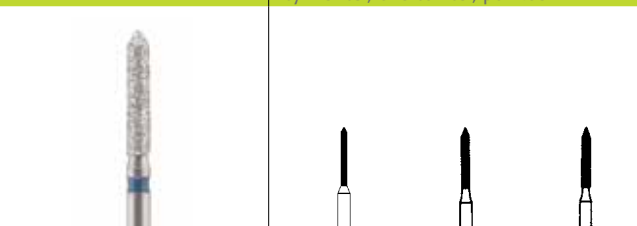

885 zylindrisch, Stirn konisch, spitz
cylindrical, end conical, pointed



ISO	Ø		
806 314 130	010	012	014
باند‌های موجود			
L mm	8,0	8,0	8,0

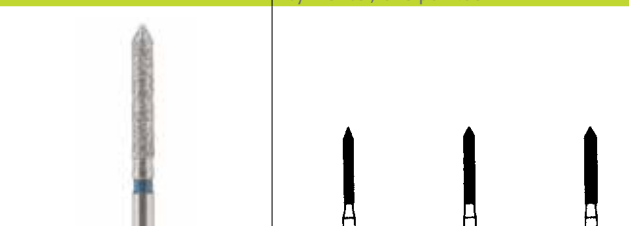



886 zylindrisch, Stirn spitz
cylindrical, end pointed

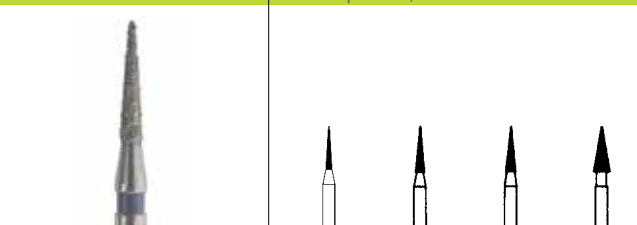

ISO	Ø		
806 314 131	012	014	016
باند‌های موجود			
L mm	10,0	10,0	10,0



898 konisch spitz, schlank
conical pointed, slender

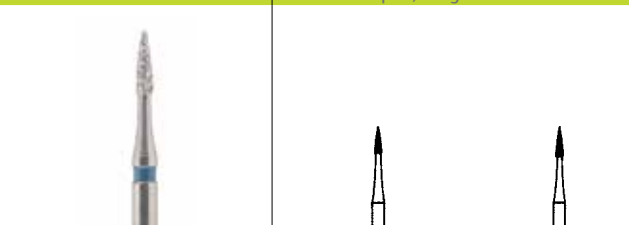

ISO	Ø			
806 314 164	010	012	014	016
باند‌های موجود				
L mm	6,0	6,0	6,0	6,0

889L Nadelform, langer Hals
needle-shaped, long neck



ISO	Ø	
806 314 540	009	010
باند‌های موجود		
L mm	3,5	4,0





893 halbrund, konkave Seite
hemispherical, concave side





ISO	Ø
806 314 507	023
باند‌های موجود	
L mm	5,8

893H konkave Seite, mit Ansatz
concave side, mit Ansatz



ISO	Ø
806 314 707	023
باند‌های موجود	
L mm	7,6

899 abgerundet, konisch spitz
rounded, conical pointed

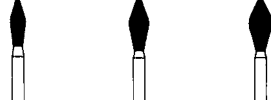
ISO	Ø
806 314 033	021 027 031
باند‌های موجود	
L mm	6,5 7,0 7,0

907 Rad, Rand halbrund
wheel, half-circle rim







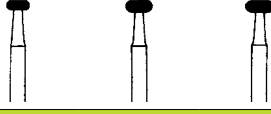

ISO	Ø
806 314 067	041
باند‌های موجود	
L mm	1,0

909 Rad
wheel

ISO	Ø
806 314 068	031 035 040
باند‌های موجود	
L mm	0,8 1,3 1,8

-  151 - 213 µm
ISO: 544
super coarse
-  107 - 181 µm
ISO: 534
coarse
-  64 - 126 µm
ISO: 524
medium

Speed diamonds



الماسی سرعت بالا

830P Flamme
flame



ISO	Ø
806 314 561 544	018 023
باند‌های موجود	
L mm	4,5 4,5

837P zylindrisch
cylindrical

ISO	Ø
806 314 562 544	012 014
باند‌های موجود	
L mm	8,0 8,0

-  27 - 76 µm
ISO: 514
fine
-  10 - 36 µm
ISO: 504
extra fine
-  4 - 14 µm
ISO: 494
ultra fine

Speed diamonds

الماسی سرعت بالا

847P		konisch, kegelstumpfförmig conical, truncated conical	
ISO	Ø		
806 314 565 544	016	018	
باند‌های موجود			
L mm	8,0	8,0	

863P		Torpedo, konisch torpedo, conical	
ISO	Ø		
806 314 571 544	014		
باند‌های موجود			
L mm	10,0		

869P		zylindrisch, Stirn konisch cylindrical, end conical	
ISO	Ø		
806 314 573 544	014	016	
باند‌های موجود			
L mm	10,0	10,0	

879P		konisch spitz conical pointed	
ISO	Ø		
806 314 575 544	016	018	
باند‌های موجود			
L mm	10,0	10,0	

Zirconia diamonds

فرزهای زیرکونیوم

Z833		Zir Prep Zir Prep	
ISO	Ø		
806 314 277 324	023		
806 314 277 314	023		
L mm	4,2		



Z850		Zir Prep Zir Prep	
ISO	Ø		
806 314 198 324	018		
806 314 198 314	018		
L mm	8,0		

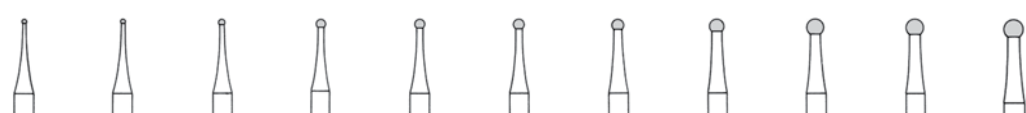

Crown cutter for the separation of zirconia crowns and bridges

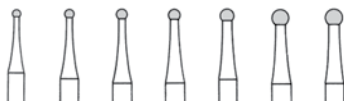

Z838L		Zir Cut Zir Cut	
ISO	Ø		
806 314 140 526	014		
L mm	6,0		

C1		kugelförmig spherical												
														
Fig	Shank	ISO	Ø											
Turbine Friction Grip مخصوص توربین														
C1	FG	500 314 001 001 -				010	012	014	016	018	021	023		
Turbine XL Friction Grip XL مخصوص توربین (شنگ بلند)														
C1	FG XL	500 316 001 001 -				010	012	014	016	018		023		
Winkelstück Right Angle مخصوص آنگل														
C1	RA	500 204 001 001 -	005	006	008	010	012	014	016	018	021	023	027	
US-No.			1/4	1/2	1	2	3	4	5	6	7	8	10	



C1S		kugelförmig, schnittfreudig spherical, high cutting efficiency											
													
Fig	Shank	ISO	Ø										
Winkelstück Right Angle مخصوص آنگل													
C1S	RA	500 204 001 003 -	010	012	014	016	018	021	023				
Winkelstück L Right Angle L مخصوص آنگل (شنگ بلند)													
C1S	RA L	500 205 001 003 -	010	012	014	016	018	021	023				

CQ1		kugelförmig, schnittfreudig, Querhieb spherical, high cutting efficiency, cross-cut											
													
Fig	Shank	ISO	Ø										
Turbine Friction Grip مخصوص توربین													
CQ1	FG	500 314 001 002 -	010	012	014	016	018	021					
Winkelstück Right Angle مخصوص آنگل													
CQ1	RA	500 204 001 002 -	010	012	014	016	018	021	023				

CQ1L		Querhieb, extra schlanker Hals cross cut, extra slender neck											
													
Fig	Shank	ISO	Ø										
Winkelstück Right Angle مخصوص آنگل													
CQ1L	RA	500 204 697 003 -	012	014	016	018							

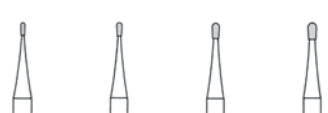
C2		umgekehrter Kegel inverted conical											
													
Fig	Shank	ISO	Ø										
Turbine Friction Grip مخصوص توربین													
C2	FG	500 314 010 001 -	010	012	014	016	018						
Winkelstück Right Angle مخصوص آنگل													
C2	RA	500 204 010 001 -	010	012	014	016	018						
L mm			1,0	1,2	1,4	1,5	1,8						

C7		Birne pear											
													
Fig	Shank	ISO	Ø										
Turbine Friction Grip													
C7	FG	500 314 237 001 -	006	008	010	012							
US-No.			329	330	331	332							
L mm			1,7	1,8	2,0	2,2							

C7L		Birne, lang pear, long											
													
Fig	Shank	ISO	Ø										
Turbine Friction Grip													
C7L	FG	500 314 238 006 -	008	010	012								
US-No.			330L	331L	332L								
L mm			3,6	4,1	4,1								

C21 Stirn und Seite schneidend
side and end cutting

Fig	Shank	ISO	Ø			
Turbine Friction Grip مخصوص توربین						
C21	FG	500 314 107 006 -	008	010	012	014
Winkelstück Right Angle مخصوص آنگل						
C21	RA	500 204 107 006 -	008	010	012	014
L mm			3,6	4,1	4,1	4,5

C21L Stirn und Seite schneidend, lang
side and end cutting, long

Fig	Shank	ISO	Ø			
Turbine Friction Grip مخصوص توربین						
C21L	FG L	500 315 110 006 -	012			
US-No.			58L			
L mm			6,3			

C21R zylindrisch, Stirn rund
cylindrical, end hemispherical

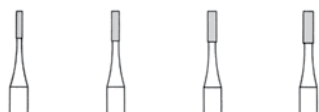
Fig	Shank	ISO	Ø	
Turbine Friction Grip مخصوص توربین				
C21R	FG	500 314 137 006 -	010	012
L mm			4,1	4,1

C23 konisch
conical

Fig	Shank	ISO	Ø			
Turbine Friction Grip مخصوص توربین						
C23	FG	500 314 168 006 -	008	009	010	012
L mm			3,6	3,8	4,1	4,1

C23L konisch
conical

Fig	Shank	ISO	Ø		
Turbine Friction Grip مخصوص توربین					
C23L	FG L	500 315 171 006 -	009	010	012
US-No.			169L	170L	171L
L mm			5,3	6,3	6,3

C23R konisch, Stirn rund
conical, end domed

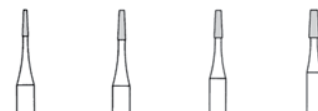
Fig	Shank	ISO	Ø		
Turbine Friction Grip مخصوص توربین					
C23R	FG	500 314 194 006 -	012		
Winkelstück Right Angle مخصوص آنگل					
C23R	RA	500 204 194 006 -	012	014	016
L mm			4,1	4,5	4,5

C31 Seite und Stirn schneidend
side and end cutting

Fig	Shank	ISO	Ø				
Turbine Friction Grip مخصوص توربین							
C31	FG	500 314 107 007 -	008	009	010	012	014
Winkelstück Right Angle مخصوص آنگل							
C31	RA	500 204 107 007 -			010	012	
L mm			3,6	3,8	4,1	4,1	4,5

C31R zylindrisch, Stirn rund
cylindrical, end hemispherical

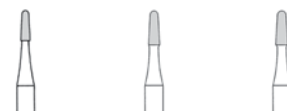
Fig	Shank	ISO	Ø	
Turbine Friction Grip مخصوص توربین				
C31R	FG	500 314 137 007 -	010	012
US-No.			1557	1558
L mm			4,1	4,1

**C33**konisch
conical

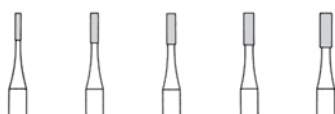
Fig	Shank	ISO	Ø			
Turbine Friction Grip مخصوص توربین						
C33	FG	500 314 168 007 -	010	012	016	021
Winkelstück Right Angle مخصوص آنگل						
C33	RA	500 204 168 007 -	012			
L mm			4,1	4,1	4,5	4,9

C33Lkonisch
conical

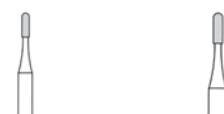
Fig	Shank	ISO	Ø	
Turbine Friction Grip مخصوص توربین بلند				
C33L	FG XL	500 316 171 007 -	010	012
US-No.			700L	701L
L mm			6,3	6,3

Carbide burs HP

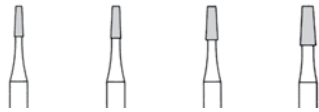
فرزهای کارباید هندپیس

C1kugelförmig
spherical

Fig	Shank	ISO	Ø										
Handstück Straight Handpiece مخصوص هندپیس													
C1	HP	500 104 001 001 -	005	006	008	010	012	014	016	018	021	023	027
US-No.			1/4	1/2	1	2	3	4	5	6	7	8	10

C21zylindrisch, Seite und Stirn schneidend
cylindrical, side and end cutting

Fig	Shank	ISO	Ø						
Handstück Straight Handpiece مخصوص هندپیس									
C21	HP	500 104 107 006 -	008	009	010	012	014	016	018
L mm			3,6	3,8	4,1	4,1	4,5	4,5	4,9

C31Seite und Stirn schneidend
side and end cutting

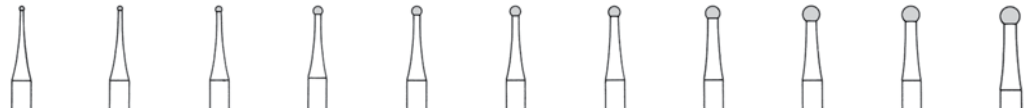

Fig	Shank	ISO	Ø					
Handstück Straight Handpiece مخصوص هندپیس								
C31	HP	500 104 107 007 -	008	010	012	014	016	018
L mm			3,6	4,1	4,1	4,5	4,5	4,9



C33Lkonisch
conical

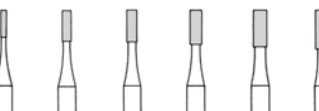

Fig	Shank	ISO	Ø	
Handstück Straight Handpiece مخصوص هندپیس				
C33L	HP	500 104 171 007 -	016	
L mm			6,3	

Crown cutters and Amalgam remover (Friction Grip)



فرزهای برش روکش و برداشت آمالگام (مخصوص توربین)

C17	Birne pear
	
ISO	Ø
500 314 237 008	010
L mm	1,7

C18R	konisch rund conical domed
	
ISO	Ø
500 314 196 008	010
L mm	4,0

CX21	Stirn und Seite schneidend side and end cutting
	 
ISO	Ø
500 314 107 019	010 012
L mm	4,0 4,0

CX21R	zylindrisch, Stirn rund cylindrical, end hemispherical
	
ISO	Ø
500 314 137 019	012
L mm	4,1

CX23	konisch conical
	 
ISO	Ø
500 314 168 019	010 012
L mm	4,0 4,0

CX23R	konisch rund conical domed
	
ISO	Ø
500 314 194 019	012
L mm	4,1

C36R	zylindrisch, Stirn rund cylindrical, end hemispherical
	 
ISO	Ø
504 314 139 008	012
L mm	4,0

Viper application

CBP 847 for shoulder preparation

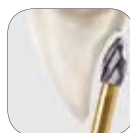

Occlusal/lingual reduction



CBP 856 for deep chamfer preparation



Easy separation of the porcelain using minimal pressure





Cuts through metal with minimal effort







Optimal for the treatment of titanium and hard alloys

Viper, One-piece tungsten carbide (Friction Grip)

فرزهای وایپر تمام کارباید (مخصوص توربین)

RRC7	Birne Pear
	
ISO	Ø
500 314 156 007	008
L mm	2,0



RRC31R	Zylindrisch, Stirn rund Cylindrical, end hemispherical
	
ISO	Ø
500 314 156 007	012
L mm	4,0

RRC31	Zylindrisch, Stirn schneidend Cylindrical, end cutting
	
ISO	Ø
500 314 109 007	010
L mm	3,7

Viper, One-piece tungsten carbide (Friction Grip)

فرزهای وایپر تمام کارباید (مخصوص توربین)

CBP847		Konisch, kegelstumpfförmig Conical, truncated	
			
ISO	Ø		
500 314 172 007	016		
L mm	8,0		

CBP379		Ei Egg	
			
ISO	Ø		
500 314 277 007	023		
L mm	4,3		

CBP856		Konisch, Stirn rund Conical, end domed	
			
ISO	Ø		
500 314 546 007	016	018	
L mm	8,0	8,0	



Carbide Finishing burs (Friction Grip)

فرزهای کارباید پرداخت (مخصوص توربین)

Blades / پره ها



C-	8-12 blades - without ring (fine)	C-F	16 - 20 Schneiden - gelber Ring (extra fein)	C-U	30 blades - white ring (ultra fine)
----	-----------------------------------	-----	--	-----	-------------------------------------

C44E		Geschoss longitudinal ellipsoidal	
			
ISO	Ø		
500 314 499 072	014	023	
L mm	3,3	3,8	



C46		Knospe bud	
			
ISO	Ø		
500 314 254 072	012		
L mm	3,4		



C379		Ei egg	
			
ISO	Ø		
500 314 277 072	018	023	
500 314 277 042	018	023	
500 314 277 032	018	023	
L mm	3,5	4,2	

C134		konisch spitz, schlank conical pointed, slender	
			
ISO	Ø		
500 314 164 071	014		
500 314 164 041	014		
500 314 164 031	014		
L mm	6,0		

C135		konisch spitz, schlank conical pointed, slender	
			
ISO	Ø		
500 314 166 071	014		
500 314 166 041	014		
500 314 166 031	014		
L mm	9,0		

C48L		Stirn flammenförmig lang long ogival end	
			
ISO	Ø		
500 314 249 072	010	012	
500 314 249 042		012	
500 314 249 032		012	
L mm	8,0	8,0	

C246		Nadelform, kurz pointed, short	
			
ISO	Ø		
500 314 496 071	009	010	
L mm	3,6	3,6	

C247		Fissurotomie Fissurotomy	
			
ISO	Ø		
500 314 195 071	010		
L mm	3,6		

Steel instruments (Right Angle)

فرزهای استیل (مخصوص آنگل)

1 kugelförmig (rund) / spherical (round)

Fig	Shank	ISO	Ø													
-----	-------	-----	---	--	--	--	--	--	--	--	--	--	--	--	--	--

Winkelstück | Right Angle | مخصوص آنگل

1	RA	310 204 001 001 -	005	006	008	010	012	014	016	018	021	023	025	027	029	031
US-No.			1/4	1/2	1	2	3	4	5	6	7	8	9	10	11	

41 konisch rund / conical domed

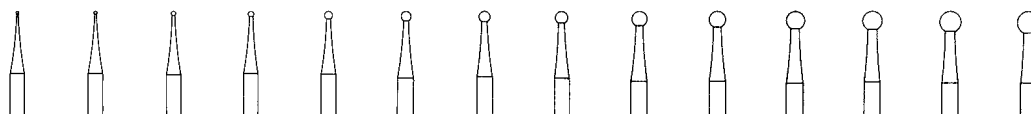
Fig	Shank	ISO	Ø						
-----	-------	-----	---	--	--	--	--	--	--

Winkelstück | Right Angle | مخصوص آنگل

41	RA	310 204 001 071 -	012	014	016	018	021	023
----	----	-------------------	-----	-----	-----	-----	-----	-----

48 Flamme, normal / flame, standard

Fig	Shank	ISO	Ø						
-----	-------	-----	---	--	--	--	--	--	--

Winkelstück | Right Angle | مخصوص آنگل

48	RA	310 204 243 071 -	010	012	014	016	018	021	023
L mm			4,5	4,8	5,1	5,4	5,7	6,0	6,3

36 zylindrisch, Seite und Stirn schneidend / cylindrical, side and end cutting

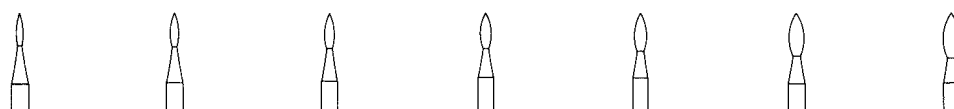
Fig	Shank	ISO	Ø					
-----	-------	-----	---	--	--	--	--	--

Winkelstück | Right Angle | مخصوص آنگل

36	RA	310 204 107 002 -	008	009	010	012	014	016
L mm			3,6	3,9	4,2	4,5	4,8	5,1



Green - Silicon carbide, Preparing porcelain, ceramic and acrylics

مولت های سنگی سبز سیلیکون کارباید، مخصوص پرسن، سرامیک و آکریل

601		kugelförmig (rund) spherical (round)
		
ISO	Ø	
Winkelstück Right Angle مخصوص آنگل		
655 204 001 523	030	

602		kugelförmig (rund) spherical (round)
		
ISO	Ø	
Winkelstück Right Angle مخصوص آنگل		
655 204 001 523	040	

645		konisch spitz conical pointed
		
ISO	Ø	
Turbine Friction Grip مخصوص توربین		
655 314 161 523	028	
Fine نرم		
655 314 161 513	028	
L mm	6,0	

649		konisch conical
		
ISO	Ø	
Winkelstück Right Angle مخصوص آنگل		
655 204 171 523	025	
L mm	6,0	

667		Knospe, schlank bud, slender
		
ISO	Ø	
Winkelstück Right Angle مخصوص آنگل		
655 204 257 523	035	
L mm	7,0	

661		Torpedo, zylindrisch torpedo, cylindrical
		
ISO	Ø	
Winkelstück Right Angle مخصوص آنگل		
655 204 288 523	025	
Turbine Friction Grip مخصوص توربین		
655 314 288 523	025	
L mm	7,0	

Pink - Fine corundum, Preparing metal and chromium cobalt alloys

مولت های سنگی صورتی، مخصوص انواع آلیاژهای فلزی و کرم کبالت

601		kugelförmig (rund) spherical (round)
		
ISO	Ø	
Winkelstück Right Angle مخصوص آنگل		
625 204 001 523	030	

649		konisch conical
		
ISO	Ø	
Winkelstück Right Angle مخصوص آنگل		
625 204 171 523	025	
L mm	6,0	

661		Torpedo, zylindrisch torpedo, cylindrical
		
ISO	Ø	
Winkelstück Right Angle مخصوص آنگل		
625 204 288 523 -	025	
L mm	7,0	

666		Knospe, schlank bud, slender
		
ISO	Ø	
Winkelstück Right Angle مخصوص آنگل		
625 204 257 523	025	
L mm	6,5	

Arkansas - Finest grinding/polishing of enamel, filling materials and all composite

مولت های آرکانزاس (سنگ سفید) مخصوص مینای دندان، مواد پر کردنی و انواع کامپوزیت ها

601	kugelförmig (rund) spherical (round)
ISO	Ø
Winkelstück Right Angle مخصوص آنگل	
635 204 001 505	030
Turbine Friction Grip مخصوص توربین	
635 314 001 505	030

645	konisch spitz conical pointed
ISO	Ø
Winkelstück Right Angle مخصوص آنگل	
635 204 161 505	028
Turbine Friction Grip مخصوص توربین	
635 314 161 505	028
L mm	7,0

649	konisch conical
ISO	Ø
Winkelstück Right Angle مخصوص آنگل	
635 204 171 505	025
Turbine Friction Grip مخصوص توربین	
635 314 171 505	025
L mm	6,0

661	Torpedo, cylindrisch torpedo, cylindrical
ISO	Ø
Winkelstück Right Angle مخصوص آنگل	
635 204 288 505	025
Turbine Friction Grip مخصوص توربین	
635 314 288 505	025
L mm	7,0

666	Knospe, schlank bud, slender
ISO	Ø
Winkelstück Right Angle مخصوص آنگل	
635 204 257 505	025
Turbine Friction Grip مخصوص توربین	
635 314 257 505	025
L mm	6,5

Polishers Orthodontia, Bracket polishers, No damage to the tooth enamel surface

مولت های ارتودنسی، براکت پالیشر، برداشت کامپوزیت و باند بدون آسیب رساندن به مینای دندان

9362	
ISO	Ø
Winkelstück Right Angle مخصوص آنگل	
635 204 307 544	100
L mm	0,7

9363	
ISO	Ø
Winkelstück Right Angle مخصوص آنگل	
635 204 297 544	034
L mm	7,5



Polisher for removing, contouring, smoothing and high-lustre polishing of amalgam and gold.

مولت های پرداخت ، فرم دادن ، پرداخت و صیقل آمالگام و طلا با بالاترین درخشش

Black (coarse): removal and contouring amalgam and gold / مولت های مشکی (زبر): برداشت و فرم دهنده آمالگام و طلا

9501GFlamme
flame

ISO

Ø

Winkelstück | Right Angle | مخصوص آنگل

653 204 243 533

030

L mm 6,0

9502GFlamme
flame

ISO

Ø

Winkelstück | Right Angle | مخصوص آنگل

653 204 243 533

050

L mm 10,0

9504Gumgekehrter Hohlkegel
inverted cone hollow

ISO

Ø

Winkelstück | Right Angle | مخصوص آنگل

653 204 030 533

060

L mm 9,5

Brown (medium): Polishing and smoothing amalgam and gold / مولت های قهوه ای (متوسط): پرداخت و هموار سازی آمالگام و طلا

9501MFlamme
flame

ISO

Ø

Winkelstück | Right Angle | مخصوص آنگل

653 204 243 513

030

L mm 6,0

9503MFlamme
flame

ISO

Ø

Winkelstück | Right Angle | مخصوص آنگل

653 204 243 513

055

L mm 15,0

9504Mumgekehrter Hohlkegel
inverted cone hollow

ISO

Ø

Winkelstück | Right Angle | مخصوص آنگل

653 204 030 513

060

L mm 9,5

9507MLinse
lens

ISO

Ø

Winkelstück | Right Angle | مخصوص آنگل

653 204 304 513

110

L mm 2,5

9150Swivel
Swivel / New!

ISO

Ø

Winkelstück | Right Angle | مخصوص آنگل

652 204 546 503

140

L mm 1,6

Green (fine): high-lustre polishing amalgam and gold / مولت های سبز (نرم): پرداخت و صیقل آمالگام و طلا با بالاترین درخشش

9501FFlamme
flame

ISO

Ø

Winkelstück | Right Angle | مخصوص آنگل

653 204 243 503

030

L mm 6,0

9504Fumgekehrter Hohlkegel
inverted cone hollow

ISO

Ø

Winkelstück | Right Angle | مخصوص آنگل

653 204 030 503

060

L mm 9,5

9144Fumgekehrter Hohlkegel
inverted cone hollow

ISO

Ø

Winkelstück | Right Angle | مخصوص آنگل

652 204 030 512

085

L mm 7,0

Universal silicon polisher - For ceramic, composite, precious metal, resins and tooth enamel

مولت های پالیش چند منظوره - مناسب برای سرامیک، کامپوزیت، فلزهای با ارزش، رزین ها و مینای دندان

9111M	Flamme flame
	
ISO	Ø
Winkelstück Right Angle مخصوص آنگل	
658 204 243 523	055
L mm	15,0

9112M	Flamme flame
	
ISO	Ø
Winkelstück Right Angle مخصوص آنگل	
658 204 243 523	045
L mm	12,0

9113M	Flamme flame
	
ISO	Ø
Winkelstück Right Angle مخصوص آنگل	
658 204 243 523	050
L mm	10,0

9114M	umgekehrter Hohlkegel inverted cone hollow
	
ISO	Ø
Winkelstück Right Angle مخصوص آنگل	
658 204 030 523	070
L mm	10,0

9115M	umgekehrter Hohlkegel inverted cone hollow
	
ISO	Ø
Winkelstück Right Angle مخصوص آنگل	
658 204 030 523	090
L mm	8,5

9119M	Flamme flame
	
ISO	Ø
Winkelstück Right Angle مخصوص آنگل	
658 204 243 523	030
L mm	6,0

Extra fine silicon polisher - For composite, gold and microfillers

مولت های پالیش خیلی نرم - مناسب برای کامپوزیت، طلا و میکرو فیلرها

9140EF	Knospe schlank bud slender
	
ISO	Ø
Winkelstück Right Angle مخصوص آنگل	
652 204 257 502	055
L mm	16,3

9141EF	Torpedo, konisch torpedo, conical
	
ISO	Ø
Winkelstück Right Angle مخصوص آنگل	
652 204 299 502	050
L mm	10,0

9142EF	Torpedo, konisch torpedo, conical
	
ISO	Ø
Winkelstück Right Angle مخصوص آنگل	
652 204 299 502	030
L mm	6,0

9143EF	umgekehrter Hohlkegel inverted cone hollow
	
ISO	Ø
Winkelstück Right Angle مخصوص آنگل	
652 204 030 502	060
L mm	10,0

9145EF	Linse mit Ansatz lens with collar
	
ISO	Ø
Winkelstück Right Angle مخصوص آنگل	
652 204 310 502	100
L mm	4,7

9837	One-step high-performance diamond polisher / New!
Diamond mirror finishing of all composite and nano ceramic	
	
ISO	Ø
Winkelstück Right Angle مخصوص آنگل	
803 204 543 503	140
L mm	1,6

Two-step high-performance diamond polisher for ceramic, zirconium and lithium disilicate / **New!**

جدید! / مولت های پالیش الماسه دو مرحله ای - مناسب برای سرامیک، زیرکونیوم، لیتیوم دیسیلیکات

LS9873M Swivel Swivel **LS9873F** Swivel Swivel / **New!**

Two-step diamond polishing system for material removal, smoothing and gloss polishing of lithium disilicate and ceramic



ISO	Ø	ISO	Ø
Right Angle مخصوص آنگل		Right Angle مخصوص آنگل	
803 204 543 522	140	803 204 543 512	140
L mm 1,6		L mm 1,6	

ZIR9863M Swivel Swivel **ZIR9863F** Swivel Swivel / **New!**

Two-step diamond polishing system for material removal, smoothing and polishing of zirconium oxide



ISO	Ø	ISO	Ø
Right Angle مخصوص آنگل		Right Angle مخصوص آنگل	
803 204 543 521	140	803 204 543 511	140
L mm 1,6		L mm 1,6	

Three-step diamond polishing system for material removal, smoothing and high-lustre polishing of porcelain, ceramic and resins

مولت های پالیش سه مرحله ای - مناسب برای فرم دادن، پرداخت و صیقل سرامیک، پرسن و رزین ها با بالاترین درخشش

9133G Flamme flame

ISO	Ø
Winkelstück Right Angle مخصوص آنگل	
658 204 243 524	050
L mm	10,0

9134G umgekehrter Hohlkegel inverted cone hollow

ISO	Ø
Winkelstück Right Angle مخصوص آنگل	
658 204 030 524	070
L mm	10,0

1395 Kit Three-step porcelain polisher

ISO	Ø
Winkelstück Right Angle مخصوص آنگل	
JOTA Silicon Polisher Kit for Ceramic	
L mm	10,0

9133M Flamme flame

ISO	Ø
Winkelstück Right Angle مخصوص آنگل	
658 204 243 514	050
L mm	10,0

9134M umgekehrter Hohlkegel inverted cone hollow

ISO	Ø
Winkelstück Right Angle مخصوص آنگل	
658 204 030 514	070
L mm	10,0

1899 Kit Two-step composite polisher

ISO	Ø
Winkelstück Right Angle مخصوص آنگل	
JOTA Silicon Polisher Kit for Ceramic	

9133F Flamme flame

ISO	Ø
Winkelstück Right Angle مخصوص آنگل	
658 204 243 504	050
L mm	10,0

9134F umgekehrter Hohlkegel inverted cone hollow

ISO	Ø
Winkelstück Right Angle مخصوص آنگل	
658 204 030 504	070
L mm	10,0

1111 Bürste - zylindrisch brush - cylindrical / **New!**

Abrasive-impregnated brushes
For polishing metal, porcelain and composite materials
Polishing paste is not required



« برس پرداخت پرسن و کامپوزیت بدون نیاز به خمیر پالیش »

ISO	Ø
Winkelstück Right Angle مخصوص آنگل	
655 204 010 504	050
L mm	6,5

Endodontics instruments

محصولات اندو

NiTi Roto File

 Feile, Typ K
file, type K

Fig	Shank	ISO	Ø					
Winkelstück Right Angle مخصوص آنگل								
173NITIR	RA	346 206 641 462	030	030	030	030	025	020
L mm			17	23	23	23	23	23
Konizität Taper			12	8	6	4	4	4
Drehmoment Torsional Ncm			3,68	2,35	2,03	1,26	0,64	0,48

K File

 Feile, Typ K
file, type K

Fig	L mm	ISO	Ø								
Handgriff Kurz, Kunststoff Handle short, plastic دستی											
173P	25	340 654 646 452 -	006	008	010	015	020	025	030	035	040

Gates

 Erweiterer, Typ G, mit Führungzapfen rostfreier Stahl
enlarger, type G, with guiding tip stainless steel

Fig	L	Tot. L	Shank	ISO	Ø					
Winkelstück Right Angle مخصوص آنگل										
180GRF	19	32	RA	330 206 679 336 -	050	070	090	110	130	150

Peeso

 Erweiterer, Typ P, mit Führungzapfen rostfreier Stahl
enlarger, type P, with guiding tip stainless steel

Fig	L	Tot. L	Shank	ISO	Ø					
Winkelstück Right Angle مخصوص آنگل										
183RF	19	32	RA	330 206 682 336 -	070	090	110	130	150	170

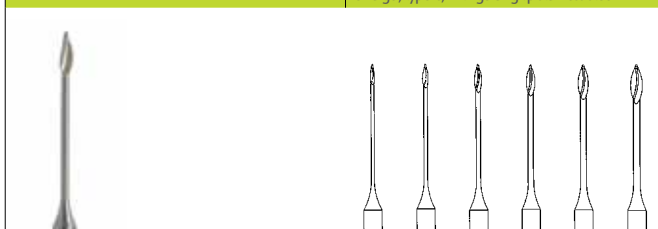
191RF

 Pulpabohrer, Typ Müller, extra lang rostfreier Stahl
spherical bur, Müller type, extra long stainless steel

Fig	L mm	Shank	ISO	Ø				
Winkelstück Right Angle مخصوص آنگل								
191RF	18	RA	330 206 698 001 -	100	120	140	160	180

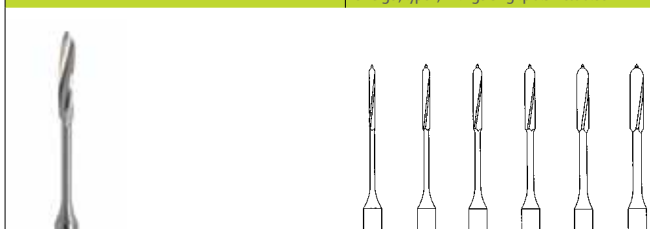
Lentulo

 Wurzelfüller, ohne Sicherheitsspirale
paste carrier, without safety spiral

Fig	L mm	Shank	ISO	Ø			
Winkelstück Right Angle مخصوص آنگل							
178L	25	RA	340 204 676 458 -	025	030	035	040

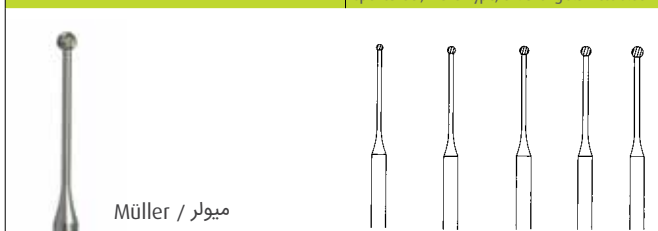
Spreader

 Füllungsverteiler, spitz
filling condenser, round tip

Fig	L mm	ISO	Ø					
Handgriff Kurz, Kunststoff Handle short, plastic دستی								
Spreader	25	340 654 632 467 -	015	020	025	030	035	040

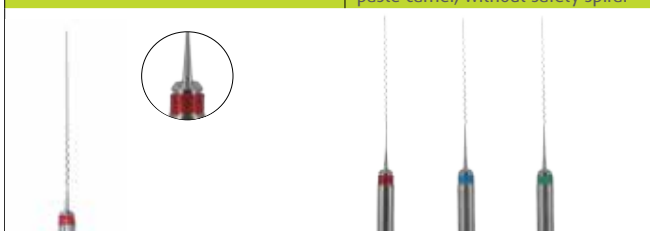
Plugger

 Wurzelkanalstopfer, scharfe Kante
filling condenser, sharp edge

Fig	L mm	ISO	Ø					
Handgriff Kurz, Kunststoff Handle short, plastic دستی								
Plugger	25	340 654 667 461 -	015	020	025	030	035	040

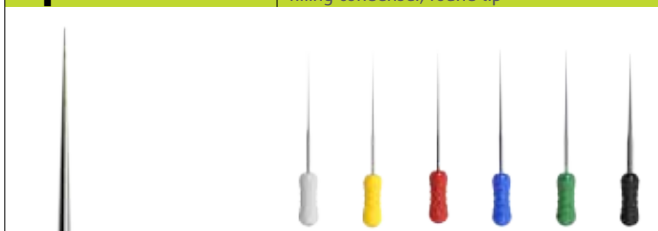
Surgical instruments - tungsten carbide

فرزهای جراحی کارباید

C1TImplantatbohrer, langer Hals
cutter for implants, long neck

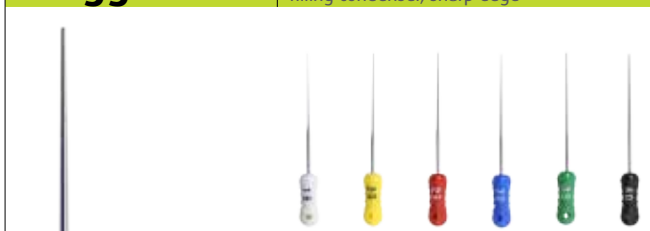
Fig	Shank	ISO	Ø
Handstück Straight Handpiece مخصوص هندپیس			
C1T	HP	500 104 697 291	023
Winkelstück Right Angle مخصوص آنگل			
C1T	RAL	500 205 697 291	023
			2

C33TImplantatbohrer, langer Hals
cutter for implants, long neck

Fig	Shank	ISO	Ø
Handstück Straight Handpiece مخصوص هندپیس			
C33T	HP	500 104 415 296	016
Winkelstück Right Angle مخصوص آنگل			
C33T	RAL	500 205 415 296	016
L mm			5,2

C1416 Schneiden
6 blades

Fig	Shank	ISO	Ø
Handstück Straight Handpiece مخصوص هندپیس			
C141	HP	500 104 001 291	023 025 027 031 035 040 050

Lindemann cutters - steel

فرزهای لیندمن - استیل

168RFKnochenfräser, Stahl rostfrei
bone cutter, stainless steel

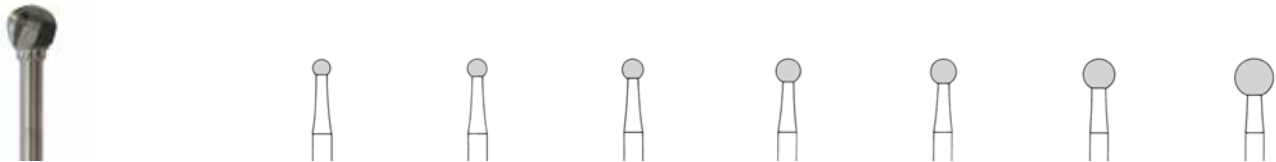
Fig	Shank	ISO	Ø
Handstück Straight Handpiece مخصوص هندپیس			
168RF	HPL	330 105 411 297	023
L mm			22,0

169RFKnochenfräser, Stahl rostfrei
bone cutter, stainless steel

Fig	Shank	ISO	Ø
Handstück Straight Handpiece مخصوص هندپیس			
169RF	HPXL	330 106 412 297	023
L mm			35,0

Surgical instruments - diamond

دیسک جراحی استئوتومی الماسی

231DOsteotomiescheibe
Osteotomic discs

Fig	Shank	ISO	Ø
Handstück Straight Handpiece مخصوص هندپیس			
231DEF	HP	806 104 064 504	070 100
Winkelstück Right Angle مخصوص آنگل			
231DEF	RA	806 204 064 504	070 100 130
L mm			0,3 0,3 0,3

Gingival trimmer - Ceramic substitute for a scalpel used for exposing healed implants

فرز سرامیکی مخصوص جراحی لته (جینجیوال تریمر) - جایگزین مناسب برای تیغ جراحی و الکترو سرجری

فرز سرامیکی توربین، بدون نیاز به آب، بدون خونریزی، برای برداشت لته، تغییر کانتور لته، اکسپوز کردن ایمپلنت، برداشت آپرکولوم، باز کردن شیار لته جهت ثبت خط تراش (فینیش لاین) با دقت بالاتر در هنگام قالبگیری، دید بهتر در سمان کردن روکش (فرز سرامیکی در محیط خشک و دور بیش از 30000rpm با ایجاد حرارت و انعقاد خون از خون ریزی جلوگیری می کند) توجه: محیط کاملا خشک باشد و با توربین بدون آب و سرعت بالا استفاده گردد، بافت نرم به صورت لایه لایه برداشته شود، برخورد فرز با وسایل فلزی باعث از بین رفتن فرز می گردد

GT48L

 Arbeitsteil aus Keramik
Ceramic working section

- Gingiva trimmer for gentle dilatation of the gingiva
- Always used without any water-/ spray-cooling



Fig	Shank	ISO	Ø
Turbine Friction Grip مخصوص توربین			
GT48L	FG	700 314 287 484 -	016
L mm			5,0

GT135

 Arbeitsteil aus Keramik
Ceramic working section

Fig	Shank	ISO	Ø
Turbine Friction Grip مخصوص توربین			
GT135	FG	700 314 161 484 -	016
L mm			8,0

Trephines - Mucosa punches

تریفاین - پانچ لته (موکتوم)

225RF

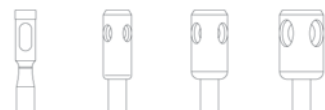
 Stahl rostfrei
stainless steel

ISO	Ø
Winkelstück Right Angle مخصوص آنگل	
330 204 485 373	021 030 040 050
L mm	4,9 6,0 6,0 6,0
	2,1 3,0 4,0 5,0

229RF

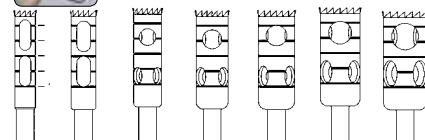
 Trepane mit Tiefenmarkierung ** - Stahl rostfrei
Trephines with depth markings ** - stainless steel

ISO	Ø
Winkelstück Right Angle مخصوص آنگل	
330 205 486 001	020 025 030 035 040 045 050
L mm	10,0 10,0 10,0 10,0 10,0 10,0 10,0
	3,0 3,5 4,0 4,5 5,0 5,5 6,0

Zubehör
Accessories
Accessoires
محصولات جانبی
GR

 45x FG / 18x RA
45x FG / 18x RA

BS24 FG-RA

 24x FG / 24x RA
24x FG / 24x RA

BS15 Mix

 10x FG + 5x RA
10x FG + 5x RA

529D

 سنگ تمیز کننده فرزهای الماسی
Diamond cleaning stone

635 000 600 524 750

303

 Träger
Mandrel

Fig	Shank	ISO	Ø
Winkelstück Right Angle مخصوص آنگل			
303	RA	312 204 603 391	050
Handstück Straight Handpiece مخصوص هندپیس			
303	HP	312 104 603 391	050

372RF

 تبدیل فرز توربین به آنگل و هندپیس
adapter sleeve on FG-instruments



ISO	Ø
Winkelstück Right Angle مخصوص آنگل	
330 204 372 434	016
Handstück Straight Handpiece مخصوص هندپیس	
330 104 372 434	016

Diamond discs

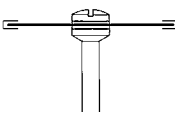
دیسک الماسی

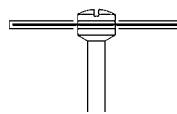
910D		Umfang und Rand schneidend peripheral and rim cutting	
			
ISO	Ø		
Rigid			
806 104 321 524	220		
L mm	0,50		

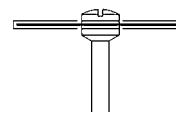
918D		Umfang, vorne, hinten schneidend peripheral, distal, proximal cutting	
			
ISO	Ø		
Rigid			
806 104 335 524	220		
L mm	0,50		

932D		Umfang, vorne, hinten schneidend peripheral, distal, proximal cutting	
			
ISO	Ø		
Flexible			
806 104 350 524	220		
L mm	0,30		

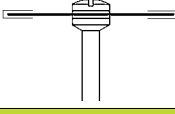
935D		Umfang und Rand schneidend peripheral and rim cutting	
			
ISO	Ø		
Flexible			
806 104 340 524	220		
L mm	0,30		

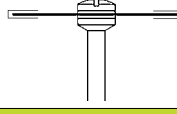
915D		Umfang und Rand schneidend peripheral and rim cutting	
			
ISO	Ø		
Super Flexible			
806 104 355 524	220		
L mm	0,25		

Carbide Cutters



فرزهای کارباید آکريل بر

C79		C78		C251		C79G	
							
ISO	Ø	ISO	Ø	ISO	Ø	ISO	Ø
500 104 194 175	045 060	500 104 257 175	060	500 104 274 175	060	500 104 194 215	045 060
L mm	12,7 12,7	L mm	12,7	L mm	14,7	L mm	12,7 12,7



C251G		CX79SF		CX78F		CX79F		CX251F	
									
ISO	Ø	ISO	Ø	ISO	Ø	ISO	Ø	ISO	Ø
500 104 274 215	060	500 104 194 141	040	500 104 257 140	060	500 104 194 140	045 060	500 104 274 140	060
L mm	14,7	L mm	14,2	L mm	12,7	L mm	12,7 12,7	L mm	14,7

Abrasives



مولت های سنگی هندپیس

SD716				SD660				642			
سنگ الماسی سبز Diamond green stone				سنگ الماسی سبز Diamond green stone				سنگ سبز سیلیکون کارباید Green silicon carbide			
 <p>› Suitable for safe dry preparation of zirconia › Optimal material removal of porcelain and metal</p>											
Fig	Shank	ISO	Ø	Fig	Shank	ISO	Ø	Fig	Shank	ISO	Ø
Handstück Straight Handpiece مخصوص هندپیس				Handstück Straight Handpiece مخصوص هندپیس				Handstück Straight Handpiece مخصوص هندپیس			
SD716F	HP	805 104 042 514	150	SD660F	HP	805 104 274 514	040	642	HP	655 104 107 523	050
Lmm 3,5				Lmm 12,0				Lmm 12,5			



Green - silicon carbide for preparing ceramic, porcelain and acrylics

653			690			716		
konisch (kegelstumpfförmig) conical (truncated conical)			Torpedo, zylindrisch torpedo, cylindrical			Scheibe disc		
								
Fig	ISO	Ø	Fig	ISO	Ø	Fig	ISO	Ø
Handstück Straight Handpiece مخصوص هندپیس			Handstück Straight Handpiece مخصوص هندپیس			Handstück Straight Handpiece مخصوص هندپیس		
653	655 104 174 523	040	690	655 104 292 523	050	716	655 104 372 523	160
Lmm 12,0			Lmm 17,0			Lmm 3,0		

Pink - high-grade corundum for preparing medium-hard metal alloys and chrome-cobalt

731			732			733		
zylindrisch, Seite und Stirn schneidend cylindrical, side and end cutting			zylindrisch, Seite und Stirn schneidend cylindrical, side and end cutting			konisch, (kegelstumpfförmig) conical, (truncated conical)		
								
Fig	ISO	Ø	Fig	ISO	Ø	Fig	ISO	Ø
Handstück Straight Handpiece مخصوص هندپیس			Handstück Straight Handpiece مخصوص هندپیس			Handstück Straight Handpiece مخصوص هندپیس		
731	625 104 107 523	065	732	625 104 107 523	050	733	625 104 173 523	035
Lmm 13,0			Lmm 12,5			Lmm 10,5		

White - high-grade corundum for preparing hard metal alloys and non-precious metal alloys

731			732			733		
zylindrisch, Seite und Stirn schneidend cylindrical, side and end cutting			zylindrisch, Seite und Stirn schneidend cylindrical, side and end cutting			konisch, (kegelstumpfförmig) conical, (truncated conical)		
								
Fig	ISO	Ø	Fig	ISO	Ø	Fig	ISO	Ø
Handstück Straight Handpiece مخصوص هندپیس			Handstück Straight Handpiece مخصوص هندپیس			Handstück Straight Handpiece مخصوص هندپیس		
731	635 104 107 524	065	732	635 104 107 524	050	733	635 104 173 524	035
Lmm 13,0			Lmm 12,5			Lmm 10,5		

Cut-off wheels and separating discs

دیسک های برش

The bend-resistant nylon cut-off wheels with low abrasion, consisting of a phenolic resin base with standard corundum abrasive, are ideal for cutting off and preparing chrome-cobalt alloys (CrCo) as well as precious and non-precious metal alloys.

584Scheibe, Umfang schneidend
disc, peripheral cutting

Fig	Shank	ISO	Ø
Unmontiert Unmounted			
584	UM	613 900 371 524	340
Lmm			1,65

587Scheibe, Umfang schneidend
disc, peripheral cutting

Fig	Shank	ISO	Ø
Unmontiert Unmounted			
587	UM	613 900 371 524	375
Lmm			1,0

581Scheibe, sehr dünn, Umfang schneidend
disc, very thin, peripheral cutting

Fig	Shank	ISO	Ø
Unmontiert Unmounted			
581	UM	613 900 358 524	220
Lmm			0,3

583Scheibe, Umfang schneidend
disc, peripheral cutting

Fig	Shank	ISO	Ø
Unmontiert Unmounted			
583	UM	613 900 371 524	250
Lmm			0,7

The nylon separating discs, consisting of a phenolic resin and silicon carbide, are ideal for separating and preparing porcelain with minimal heat build up and without contaminating grinding marks.

505Scheibe normal, Umfang schneidend
disc standard, peripheral cutting

Fig	Shank	ISO	Ø
Unmontiert Unmounted			
505	UM	653 900 327 524	220
Lmm			0,6

506Scheibe normal, Umfang schneidend
disc standard, peripheral cutting

Fig	Shank	ISO	Ø
Unmontiert Unmounted			
506	UM	653 900 320 524	220
Lmm			0,3

Kits for dental laboratories - All Ceramic and Zirconflex

کیت های لابراتواری - آلسرام و زیرکونفلکس

1322JOTA Zirconflex Kit
JOTA Zirconflex Kit**1429**JOTA All Ceramic Kit - Bearbeitung von Vollkeramik
JOTA All Ceramic Kit - Preparation of allceramics

Silicone polishers for preparing denture acrylic

مولت های پرداخت آکرلیک

9571G Torpedo, konisch
torpedo, conical

Fig	ISO	Ø
Handstück Straight Handpiece مخصوص هندپیس		
9571G	658 104 300 533	100
L mm		20,0

9572G Granate
bullet

Fig	ISO	Ø
Handstück Straight Handpiece مخصوص هندپیس		
9572G	658 104 275 533 -	100
L mm		22,0

9573G konisch, Stirn rund
conical, end domed

Fig	ISO	Ø
Handstück Straight Handpiece مخصوص هندپیس		
9573G	658 104 201 533 -	150
L mm		17,0

9571M Torpedo, konisch
torpedo, conical

Fig	ISO	Ø
Handstück Straight Handpiece مخصوص هندپیس		
9571M	658 104 300 523	100
L mm		20,0

9572M Granate
bullet

Fig	ISO	Ø
Handstück Straight Handpiece مخصوص هندپیس		
9572M	658 104 275 523	100
L mm		22,0

9573M konisch, Stirn rund
conical, end domed

Fig	ISO	Ø
Handstück Straight Handpiece مخصوص هندپیس		
9573M	658 104 201 523	150
L mm		17,0

9571F Torpedo, konisch
torpedo, conical

Fig	ISO	Ø
Handstück Straight Handpiece مخصوص هندپیس		
9571F	658 104 300 513	100
L mm		20,0

9572F Granate
bullet

Fig	ISO	Ø
Handstück Straight Handpiece مخصوص هندپیس		
9572F	658 104 275 513	100
L mm		22,0

9573F konisch, Stirn rund
conical, end domed

Fig	ISO	Ø
Handstück Straight Handpiece مخصوص هندپیس		
9573F	658 104 201 513	150
L mm		17,0

Two-step diamond polishing system for smoothing and high-lustre polishing of porcelain and zirconia

پالیشهای الماسی دو مرحله ای مخصوص پرداخت و صیقل پرسن و زیرکونیوم با بالاترین درخشش

- › Also suitable for metals – after use on metals, clean the polishers to prevent striation marks forming on the porcelain
- › Pink: smoothing and pre-polishing / grey: high-lustre polishing

9805M Swivel
Swivel

Fig	Shank	ISO	Ø
Unmontiert Unmounted			
9805M	HP	803 104 543 524	140
L mm			1,6

9805F Swivel
Swivel

Fig	Shank	ISO	Ø
Unmontiert Unmounted			
9805F	HP	803 104 543 514	140
L mm			1,6

Jota



دفتر مرکزی

تهران، خیابان آزادی، روبرو دانشکده دامپزشکی، مجتمع تجاری کاوه،
بلوک C، طبقه ۳، واحد ۱۳۰، تجهیزات دندانپزشکی اشکان (طرحورانی)
تلفکس: ۴ - ۶۶۹۰۴۴۶۳ (۰۲۱)

فروشگاه مرکزی

تهران، خیابان آزادی، روبرو دانشکده دامپزشکی، مجتمع تجاری کاوه،
شماره ۲۱، تجهیزات دندانپزشکی اشکان
تلفکس: ۸ - ۶۶۹۱۷۹۴۷ (۰۲۱)

WWW.ASHKANDENTAL.COM

OFFICE@ASHKANDENTAL.COM



تجهیزات دندانپزشکی اشکان

نماینده انحصاری در ایران
www.ashkandental.com